

Mesh Baffle - Random

- Hanging Assembly:6
- Wire Clamps:5
- Mesh:1
- Quills:219

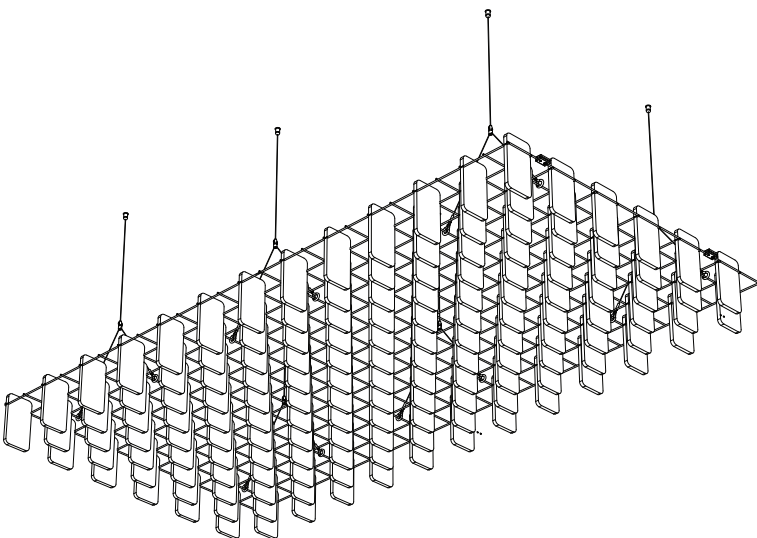
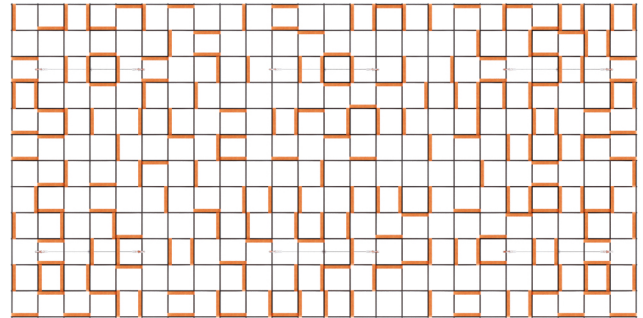

Mesh Baffle - Short Offset

- Hanging Assembly:6
- Wire Clamps:5
- Mesh:1
- Quills:150

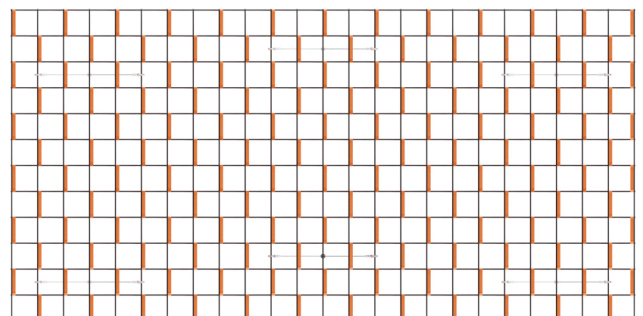

Zintra Mesh Baffles

Installation Instructions

Mesh Baffle - Long Offset

- Hanging Assembly:6
- Wire Clamp:5
- Mesh:1
- Quills:156

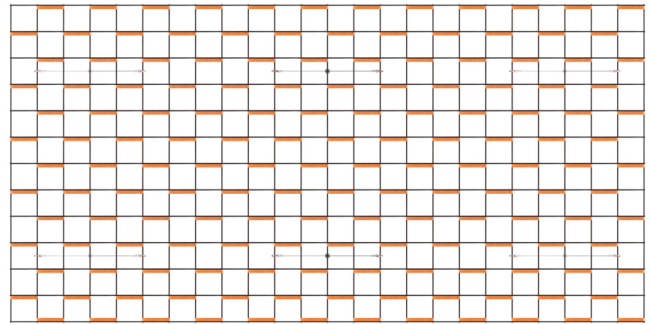
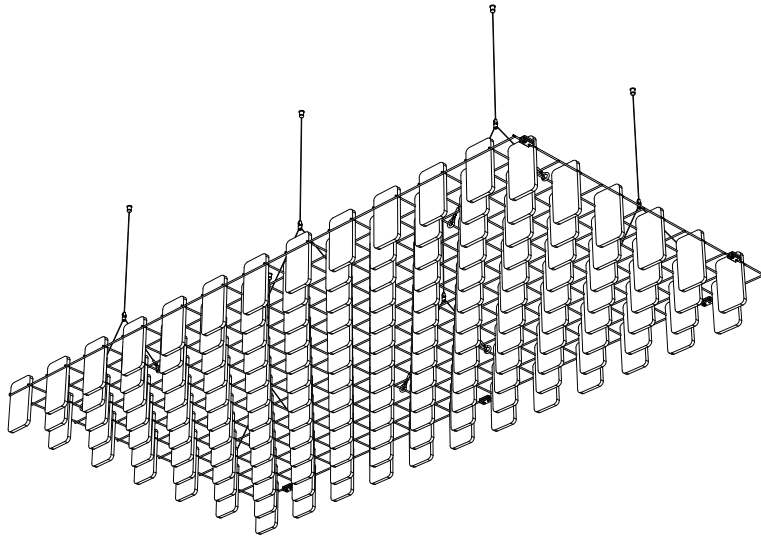

Mesh Baffle - Offset

- Hanging Assembly:6
- Wire Clamp:5
- Mesh:1
- Quills:288

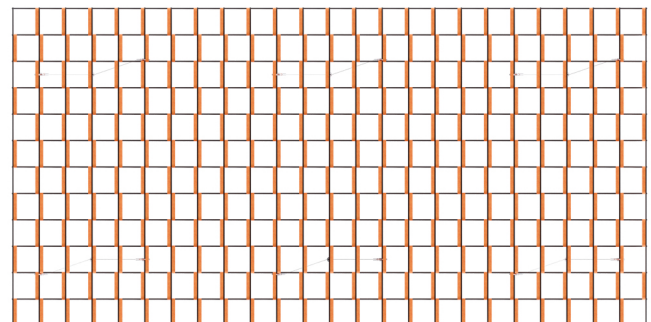
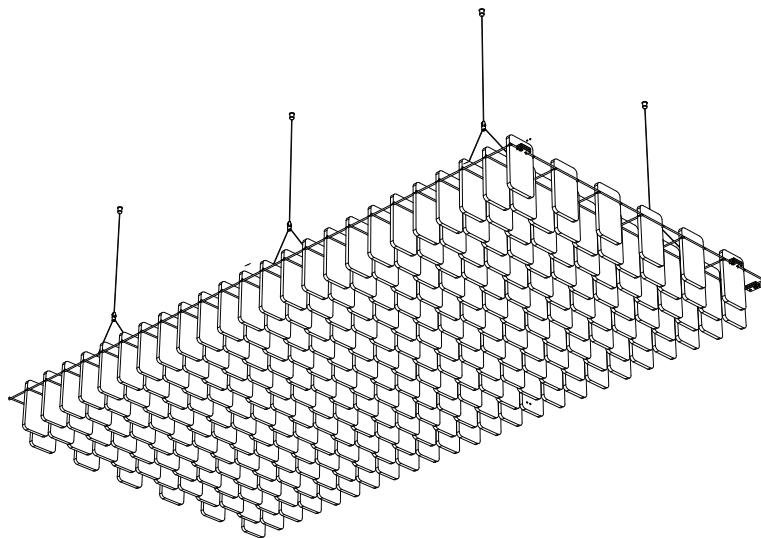

Zintra Mesh Baffles

Installation Instructions

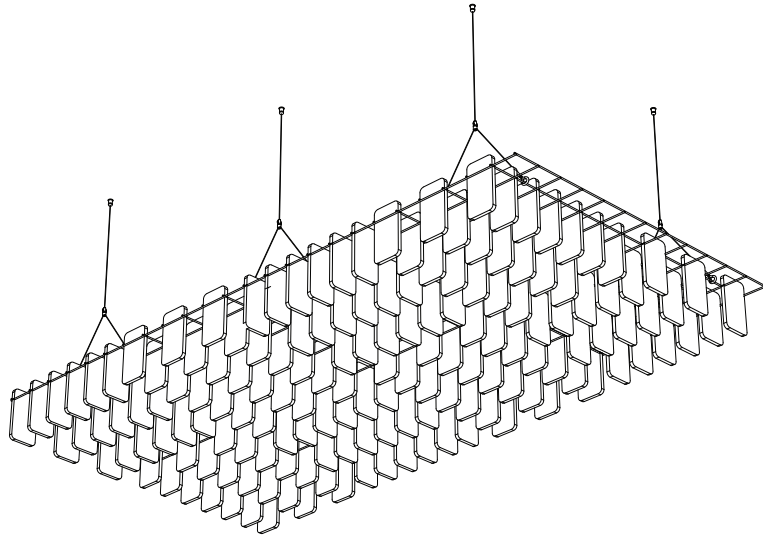

Mesh Baffle - Checkered

- Hanging Assembly:6
- Wire Clamp:5
- MESH:1
- Quills:156

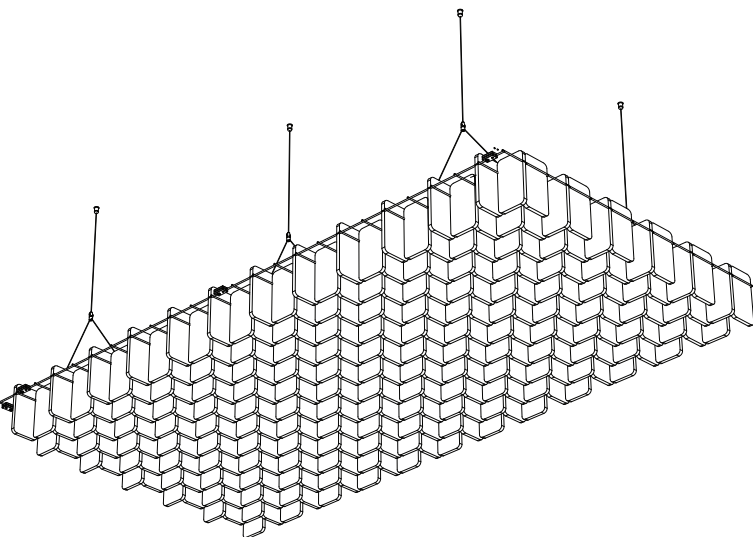
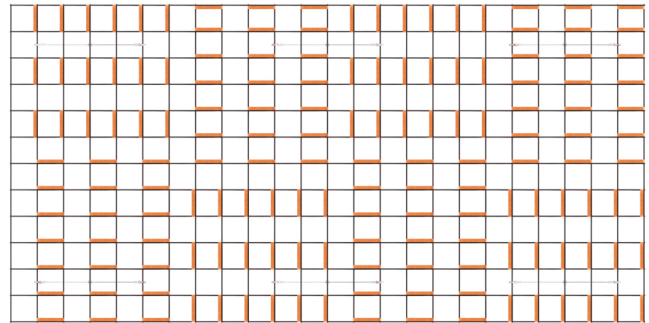

Mesh Baffle - Herringbone

- Hanging Assembly:6
- Wire Clamp:5
- Mesh:1
- Quills:288

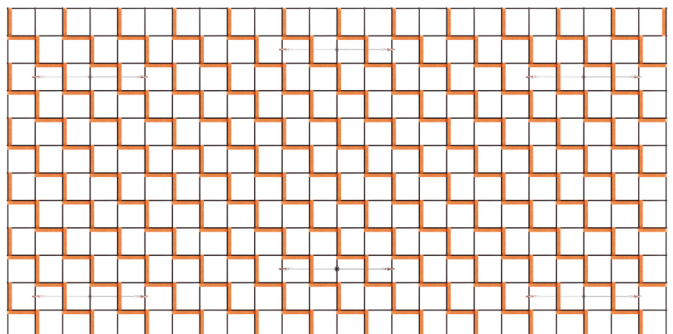

PARTS AND HARDWARE

FOR A TYPICAL ASSEMBLY

Mesh

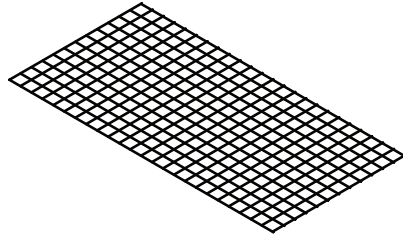

Wire Clamp

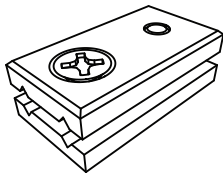

Quill

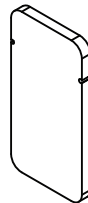

Hanging Assembly

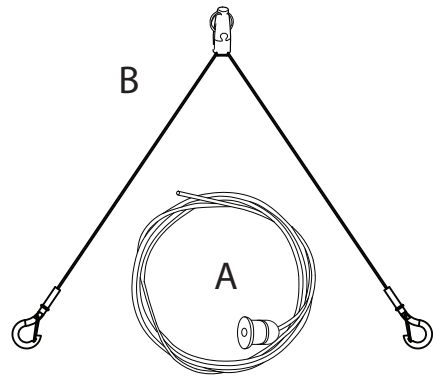

YOU WILL NEED

FOR A TYPICAL ASSEMBLY

LASER LEVEL

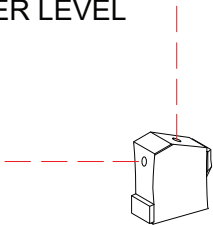

Marker pen



TYPE MEASURE

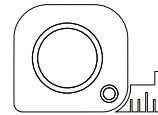

DRILL

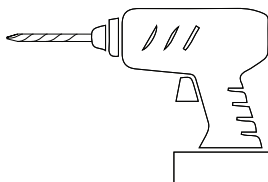

10 GAUGE SCREW



FOR A TYPICAL SYSTEM LAYOUTS

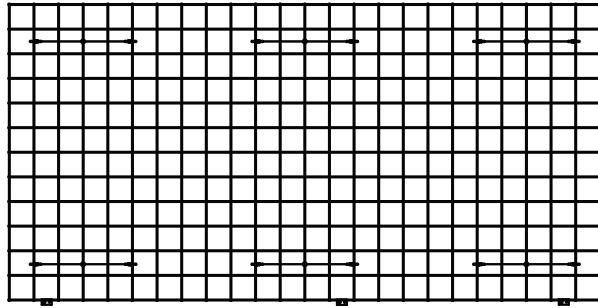

Single system

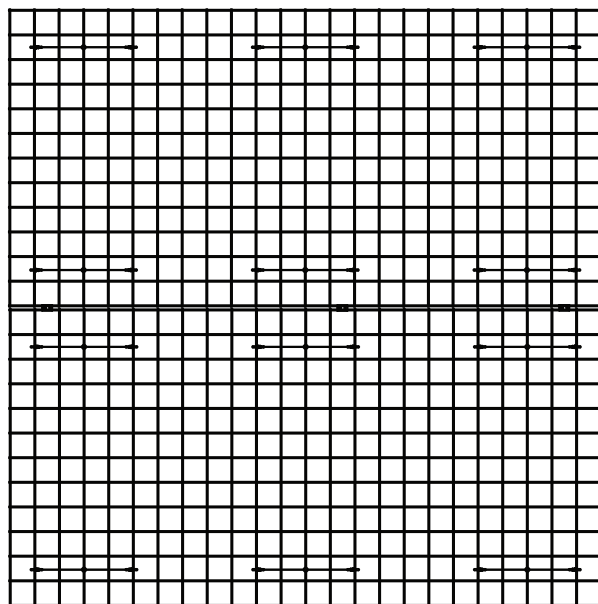

Double system long side

Zintra Mesh Baffles

Installation Instructions

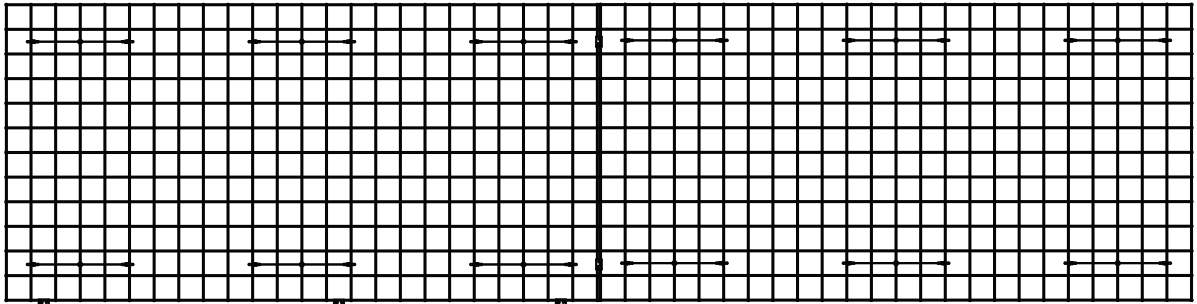

Double system short side

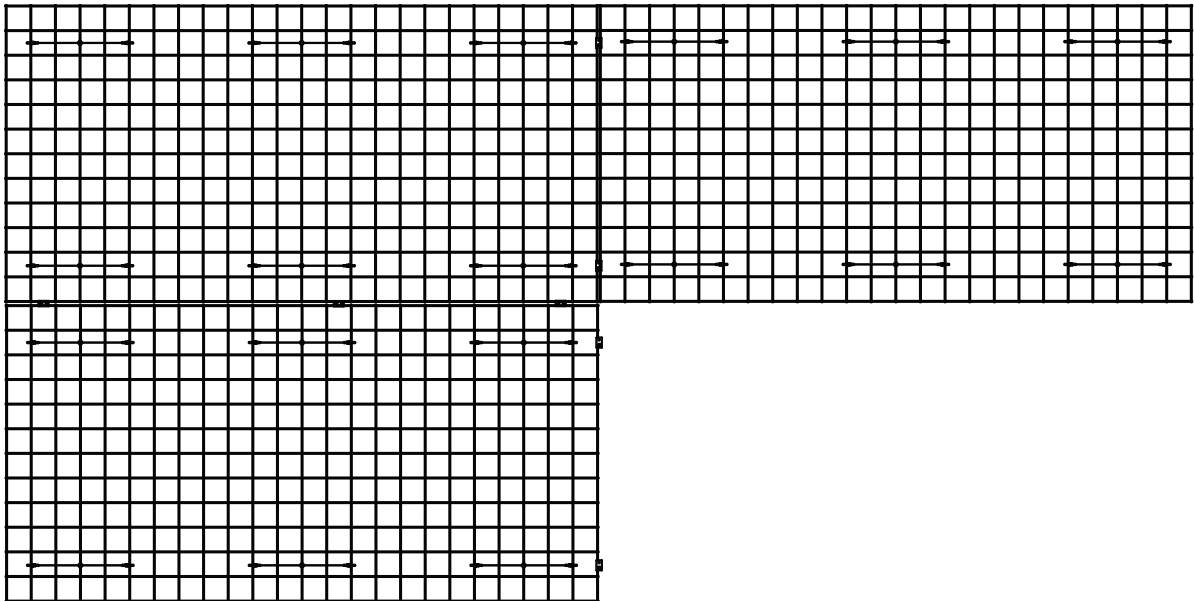

Triple + system

48X96 Mesh Baffle - Checkered

Fixing measurements

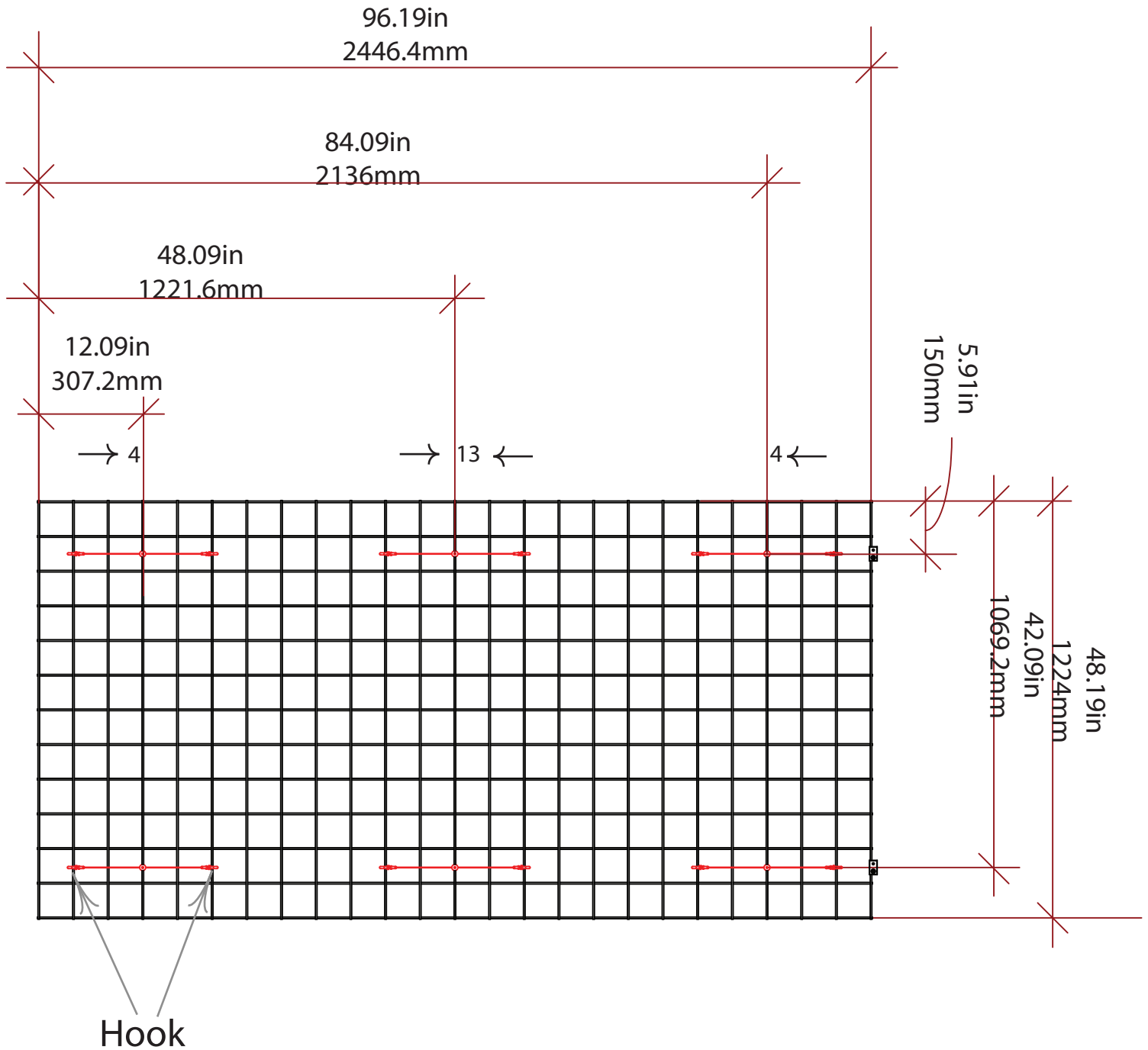

48X96 Mesh Baffle - Herringbone

Fixing measurements

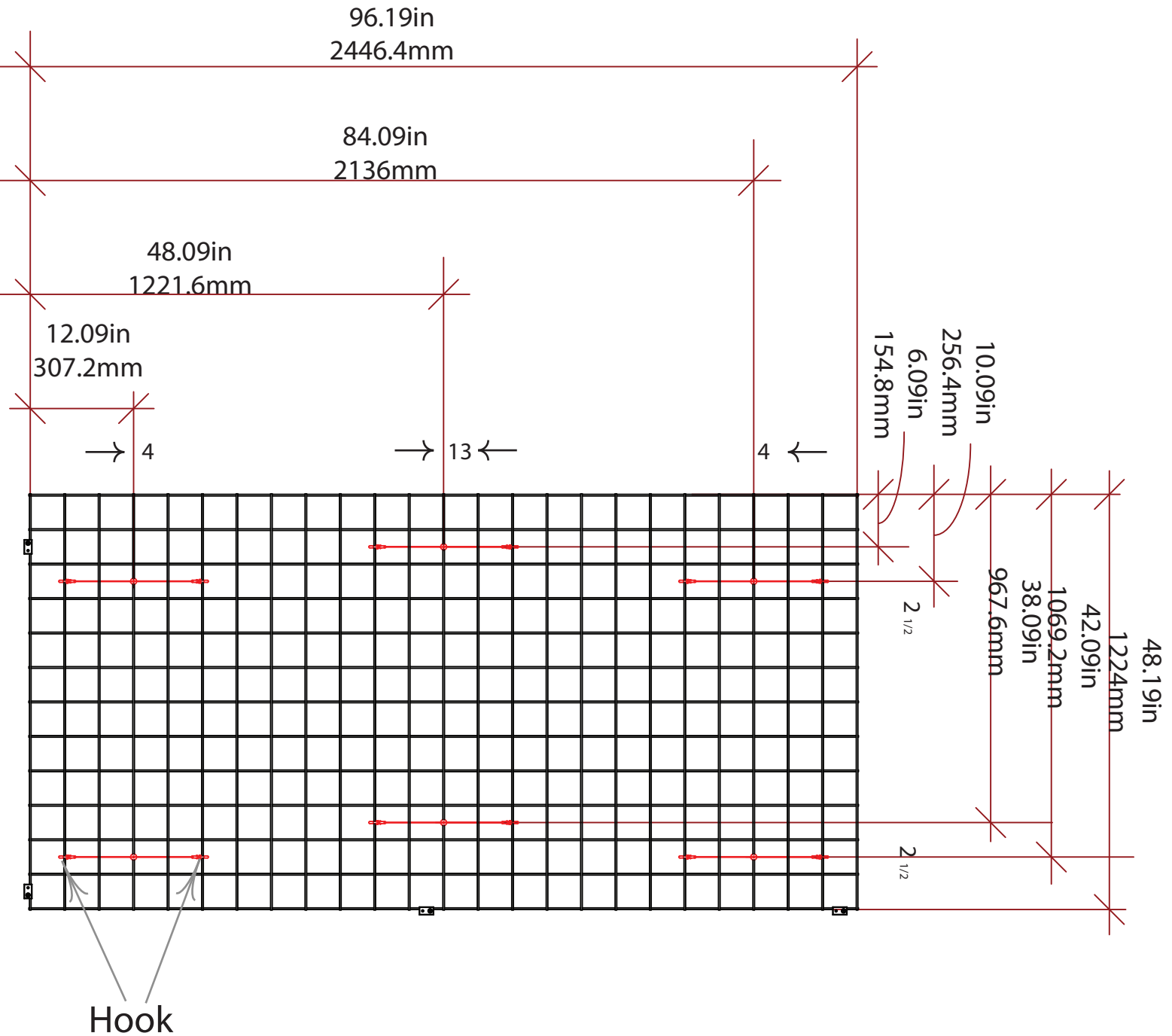

48X96 Mesh Baffle - Long Offset

Fixing measurements

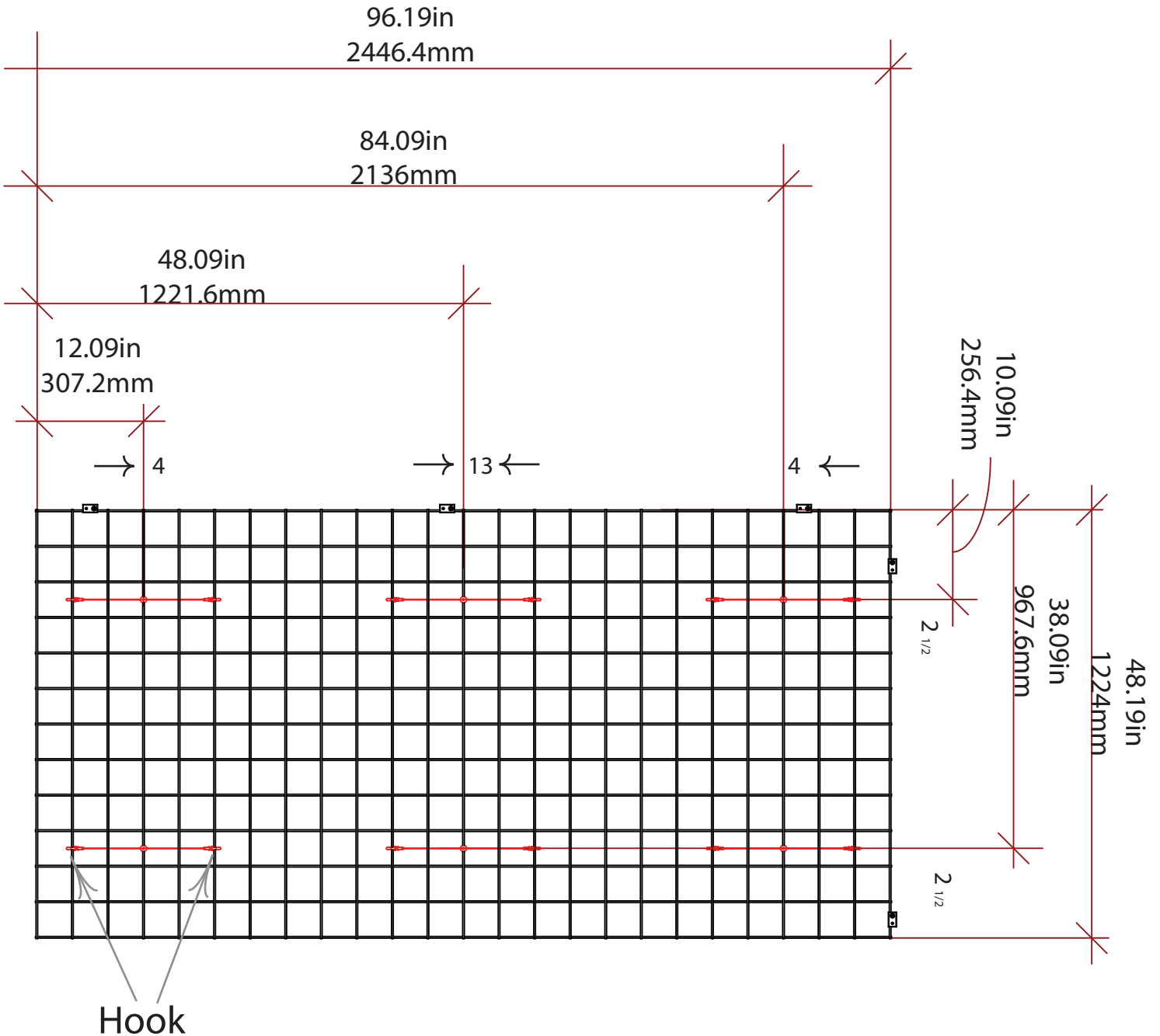

48X96 Mesh Baffle - Offset

Fixing measurements

96.19in
2446.4mm

84.09in
2136mm

48.09in
1221.6mm

12.09in
307.2mm

→ 4

→ 13 ←

← 4

8.09in
205.6mm

3

40.08in
1018.1mm

48.19in
1224mm

2

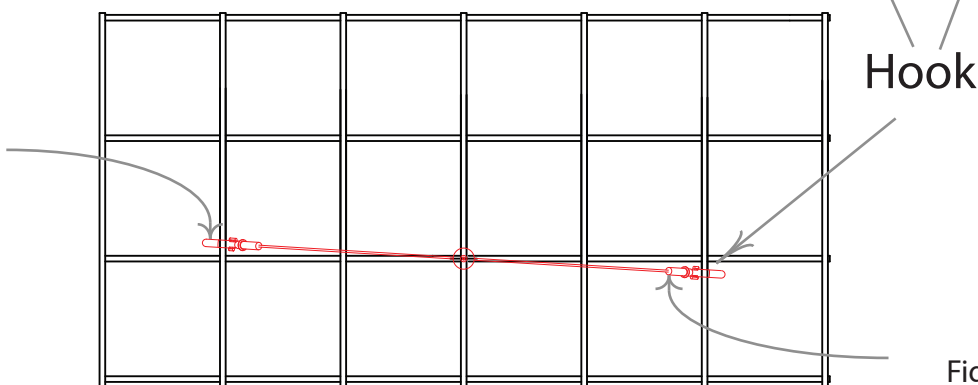
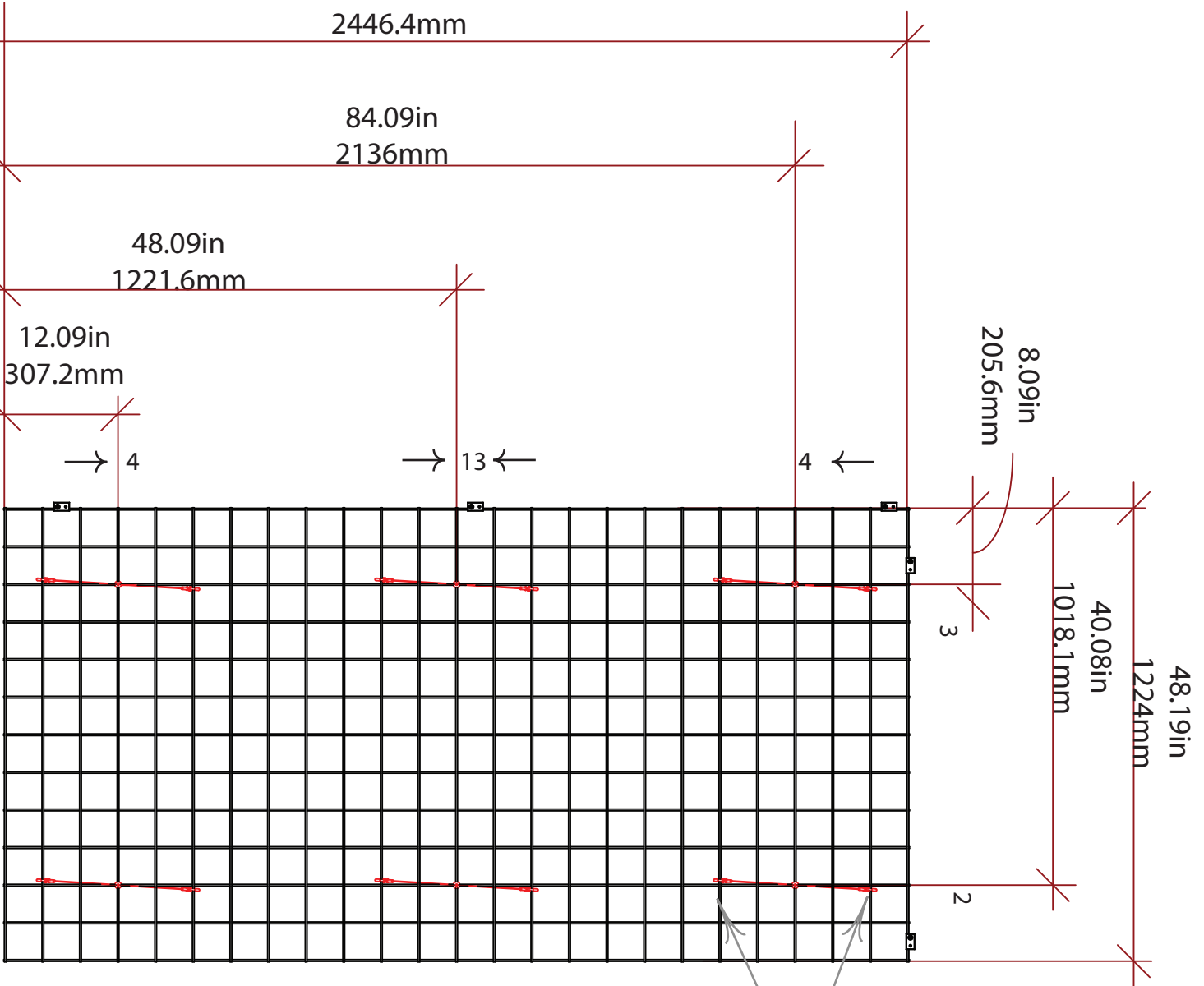

To avoid Quills
Place hooks at a slight angle

Figure 1

48X96 Mesh Baffle - Random

Fixing measurements

96.19in
2446.4mm

84.09in
2136mm

48.09in
1221.6mm

12.09in
307.2mm

→ 4

→ 13 ←

4 ←

10.09in
256.4mm

3 1/2

38.09in
967.6mm

48.19in
1224mm

3 1/2

Hook

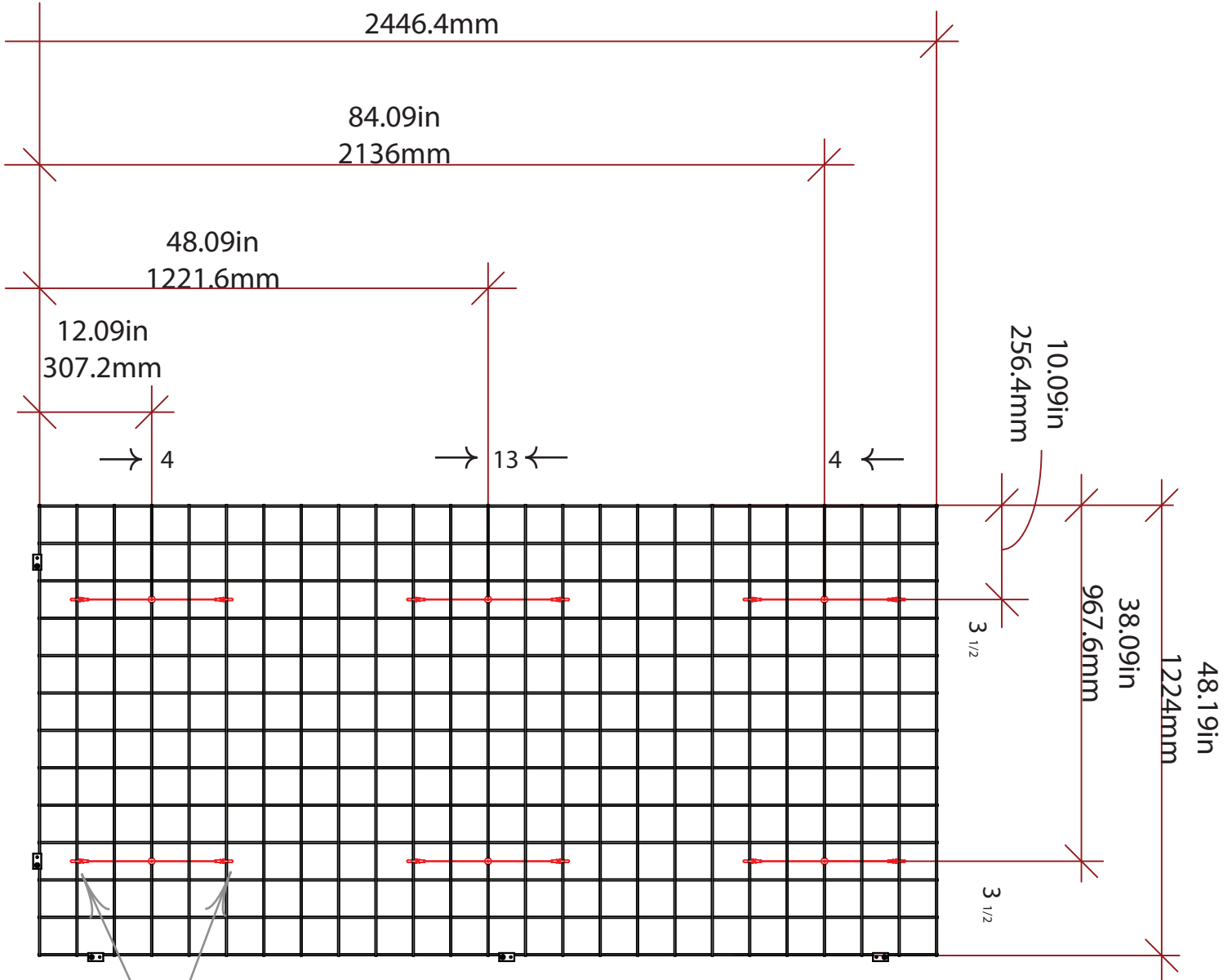

48X96 Mesh Baffle - Short Offset

Fixing measurements

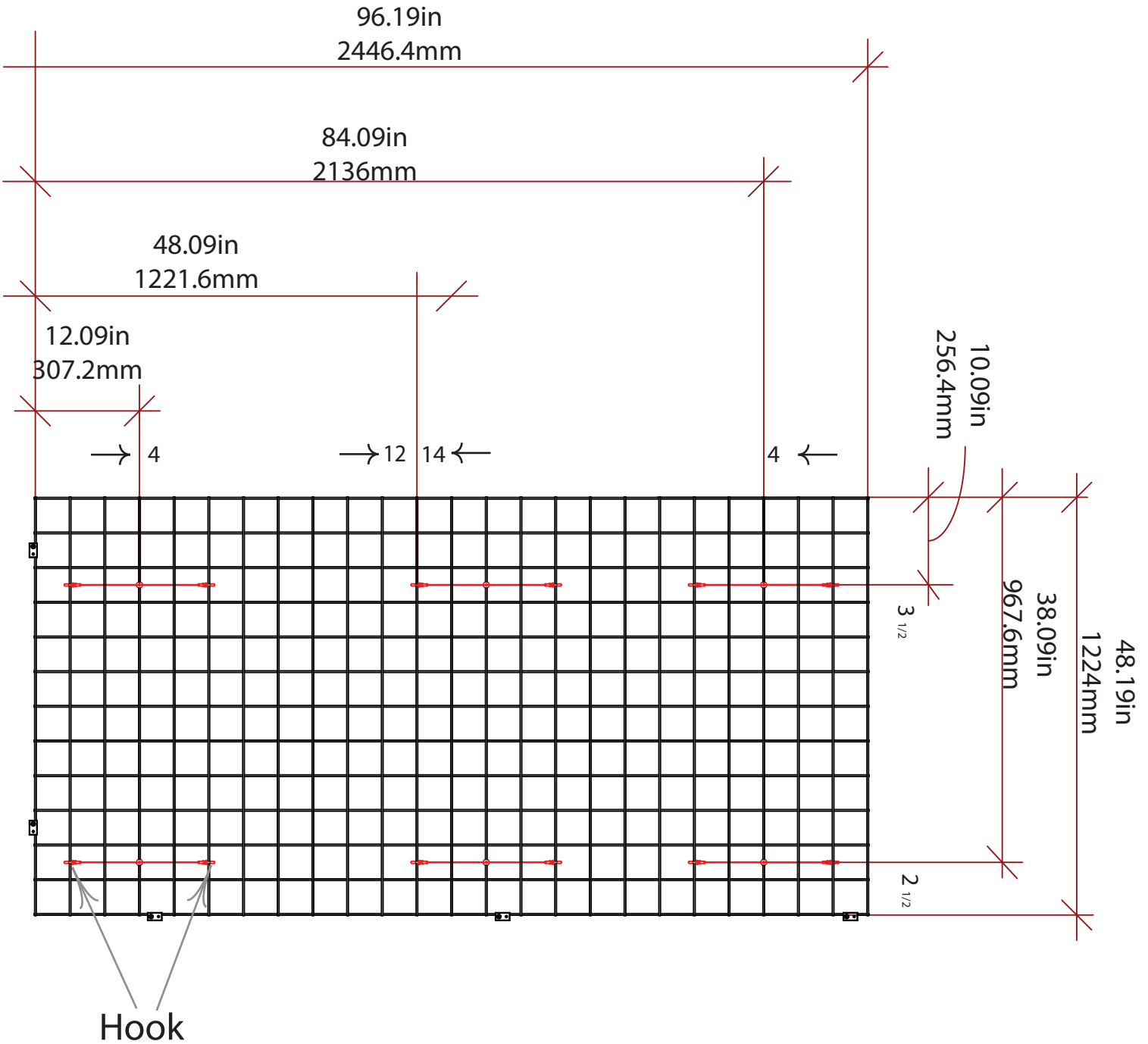

FOR A TYPICAL SYSTEM LAYOUTS

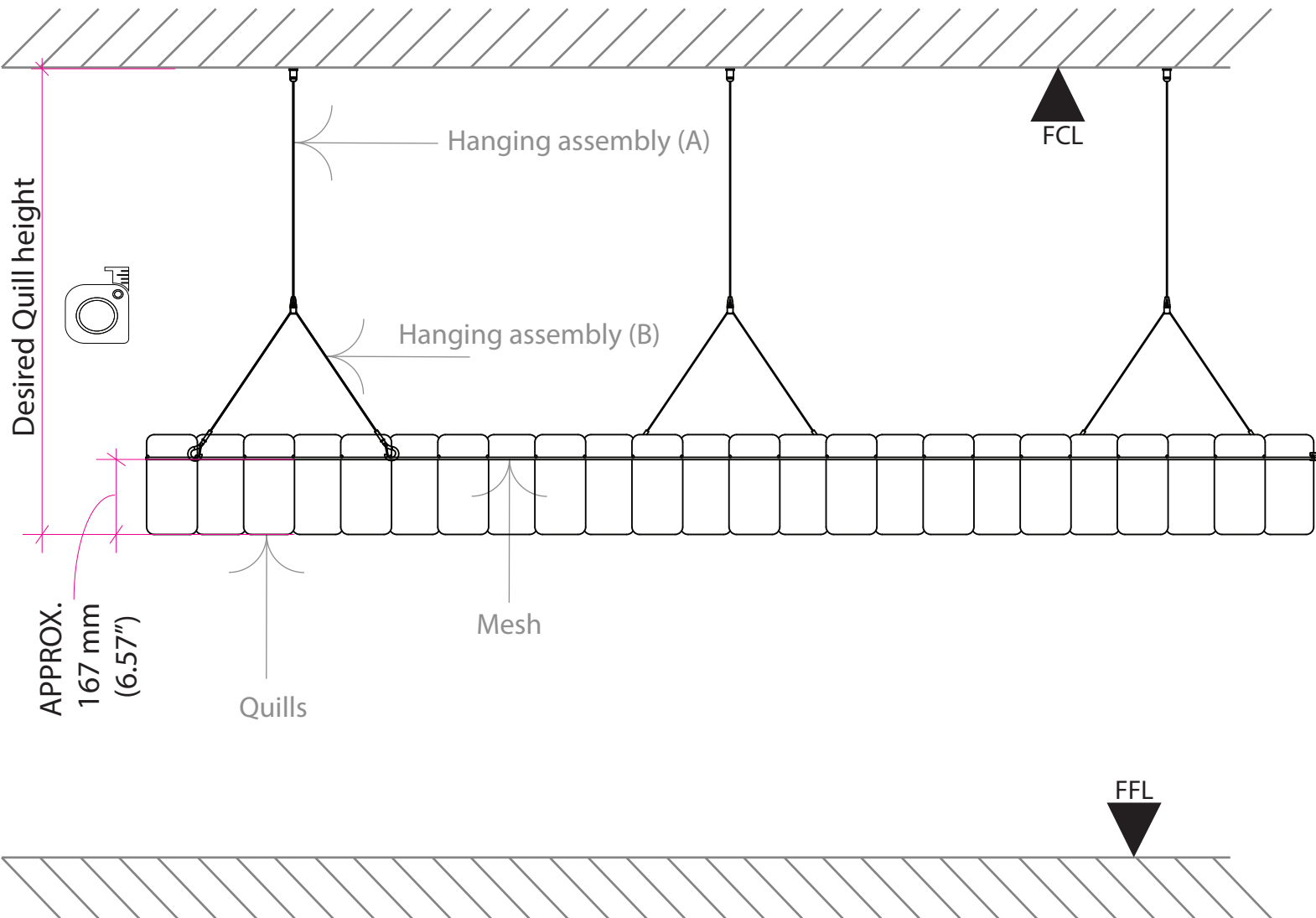

Figure 2

Make system Level and at a workable height.

Note: you will need to raise system late to it desired height.

Zintra Mesh Baffles

Installation Instructions

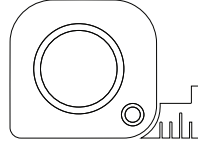

Determine the height you want your mesh baffle to hang from the ceiling

1

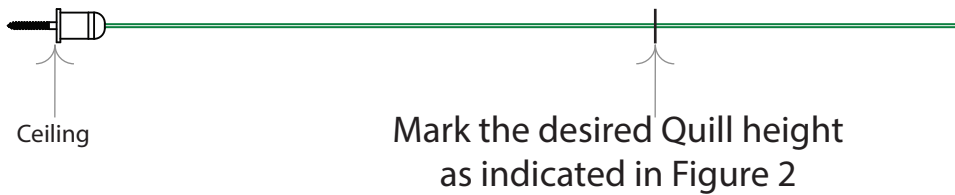

Attach Hanging assembly (A) to Hanging assembly (B)
Put the cable through Hanging assembly (A) as shown in the image below.
Stop at the mark

2

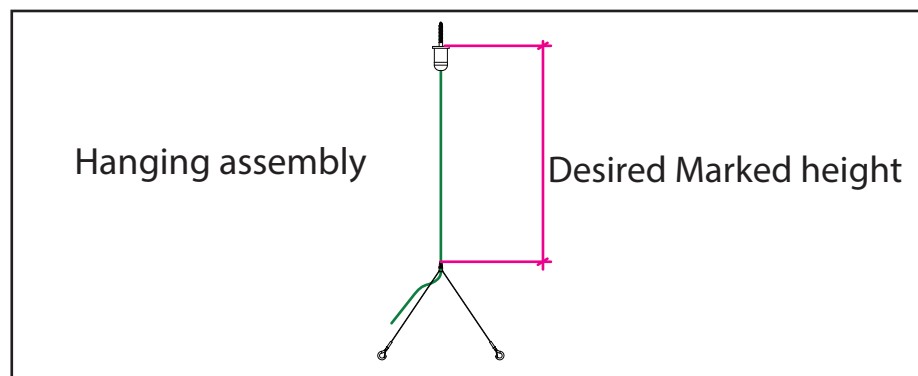

Installation

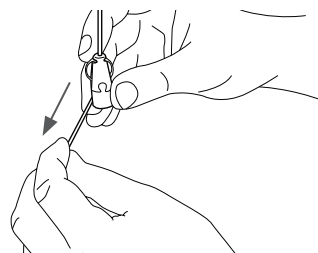
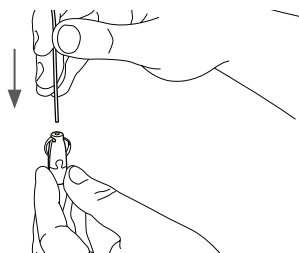

Release*

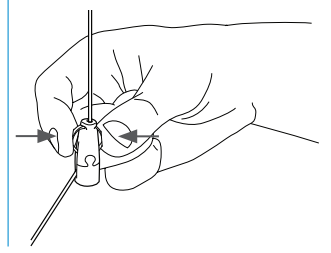

3

* When releasing: 1. Remove load, 2. Squeeze wings, 3. Raise or lower on cable

Layout your desired patten/system on the floor on as indicated on Page 5-6

With the meshes laid on the floor in design,
sit the laser on top of the mesh pointing up as indicated on the in Figure 3

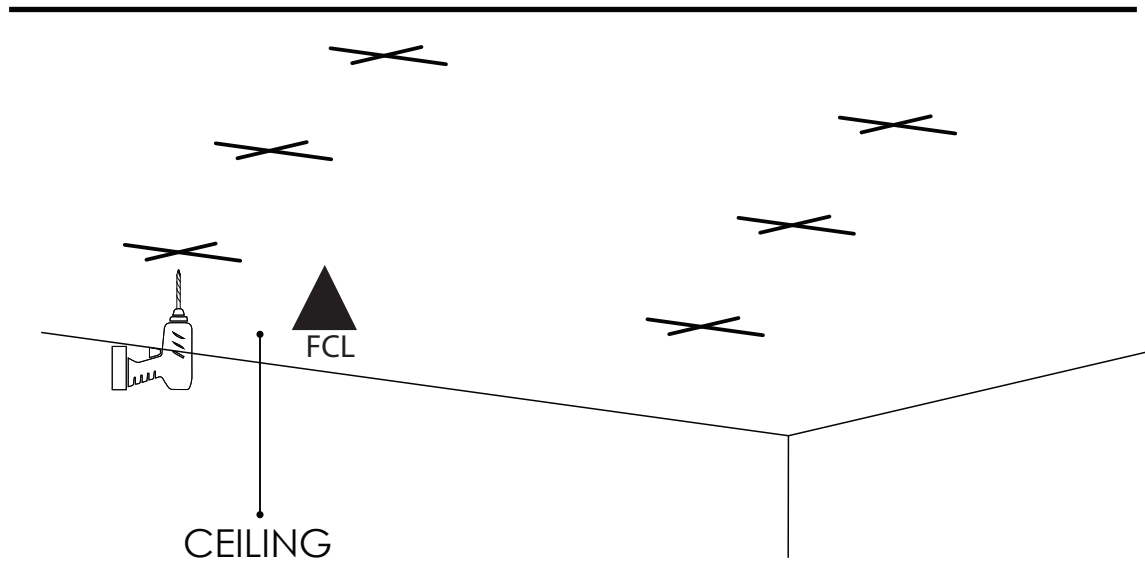
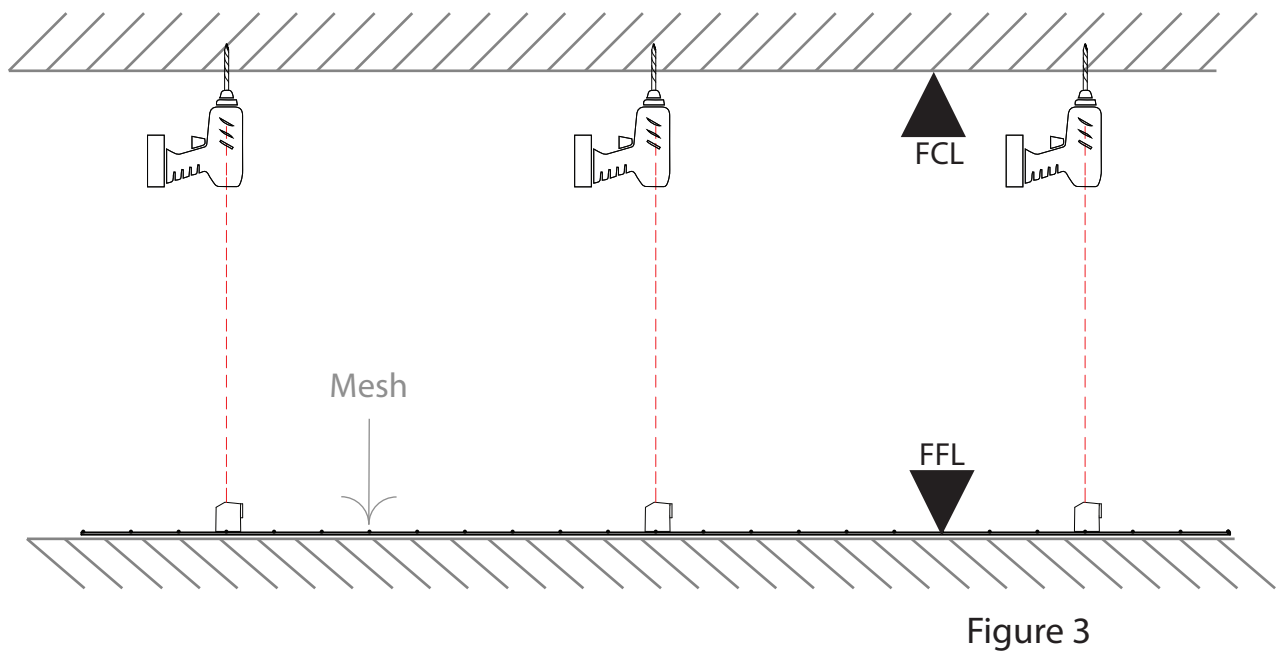

Laser fixing points as per your desired system

This is where you will need to drill your pilot hole and insert (Plug) and screw.
See Figure 4

Fix Hanging assembly (A) to ceiling
as indicated below

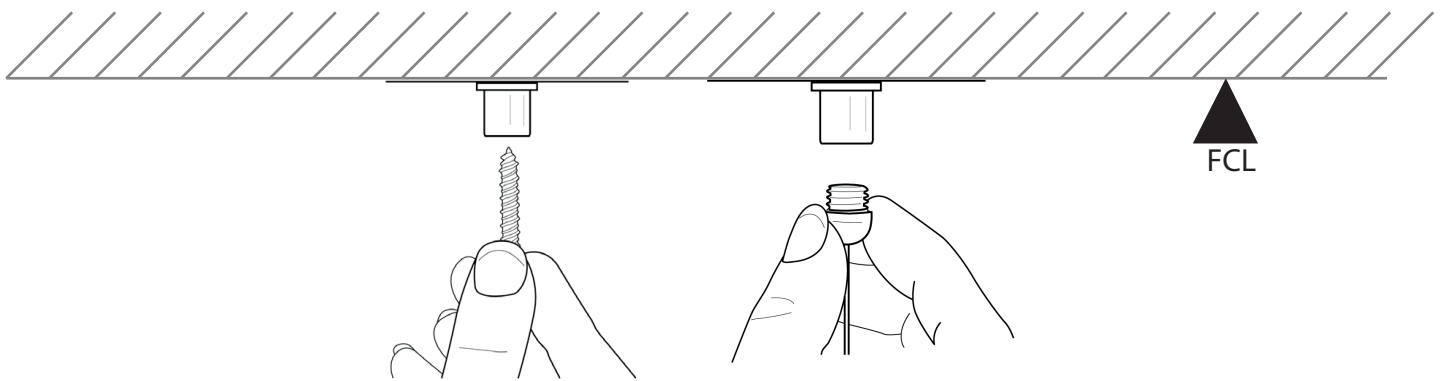
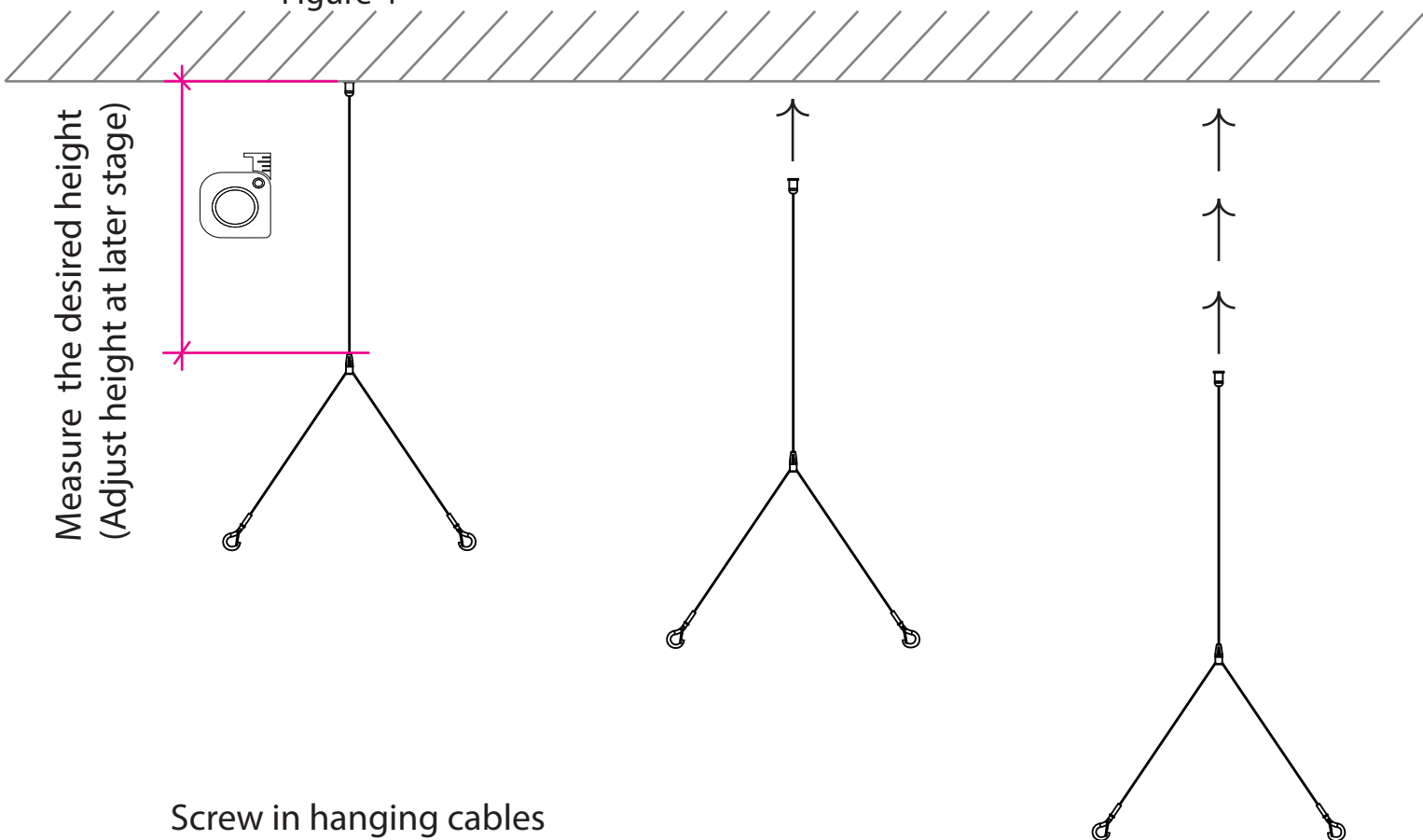
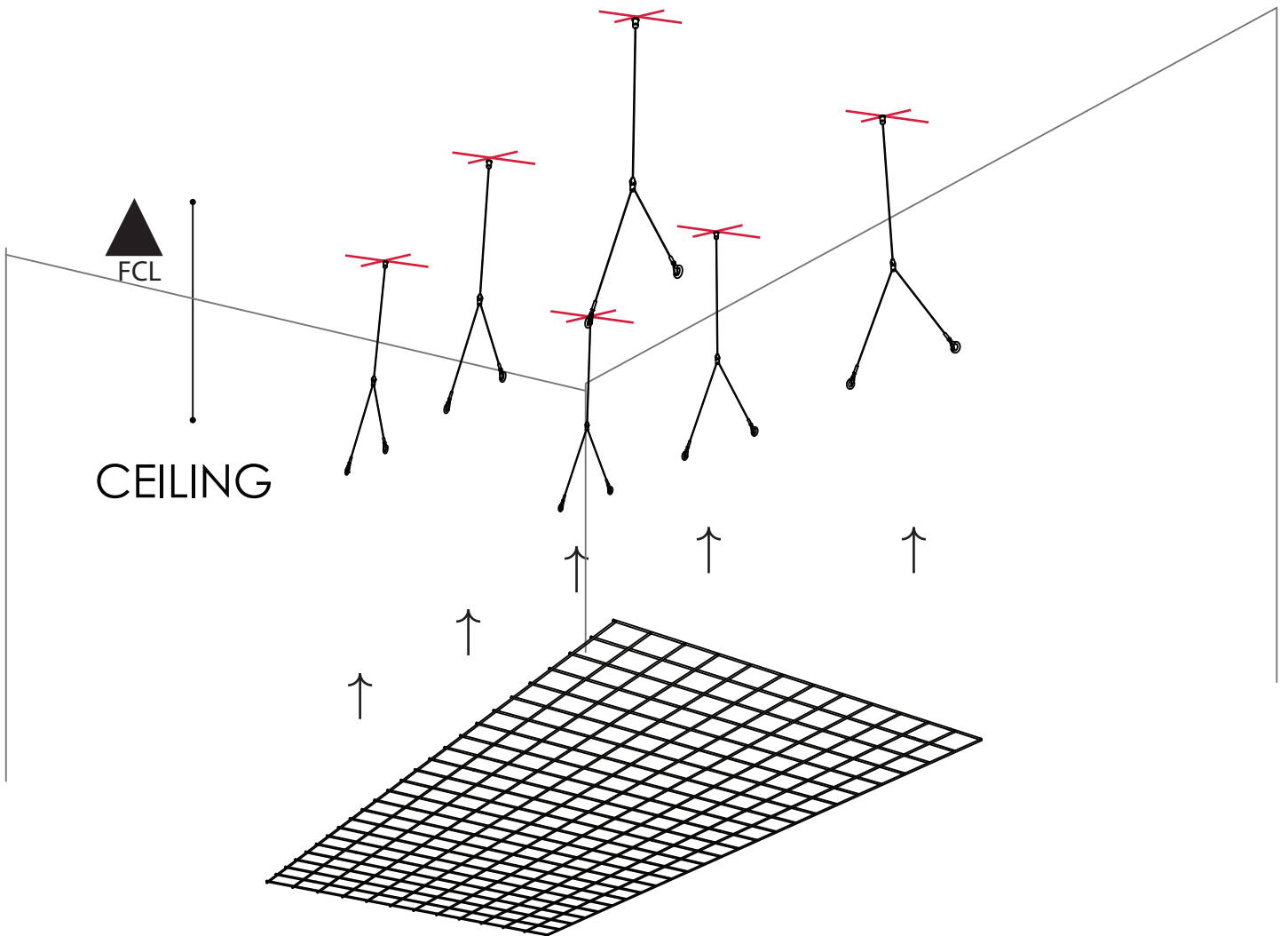
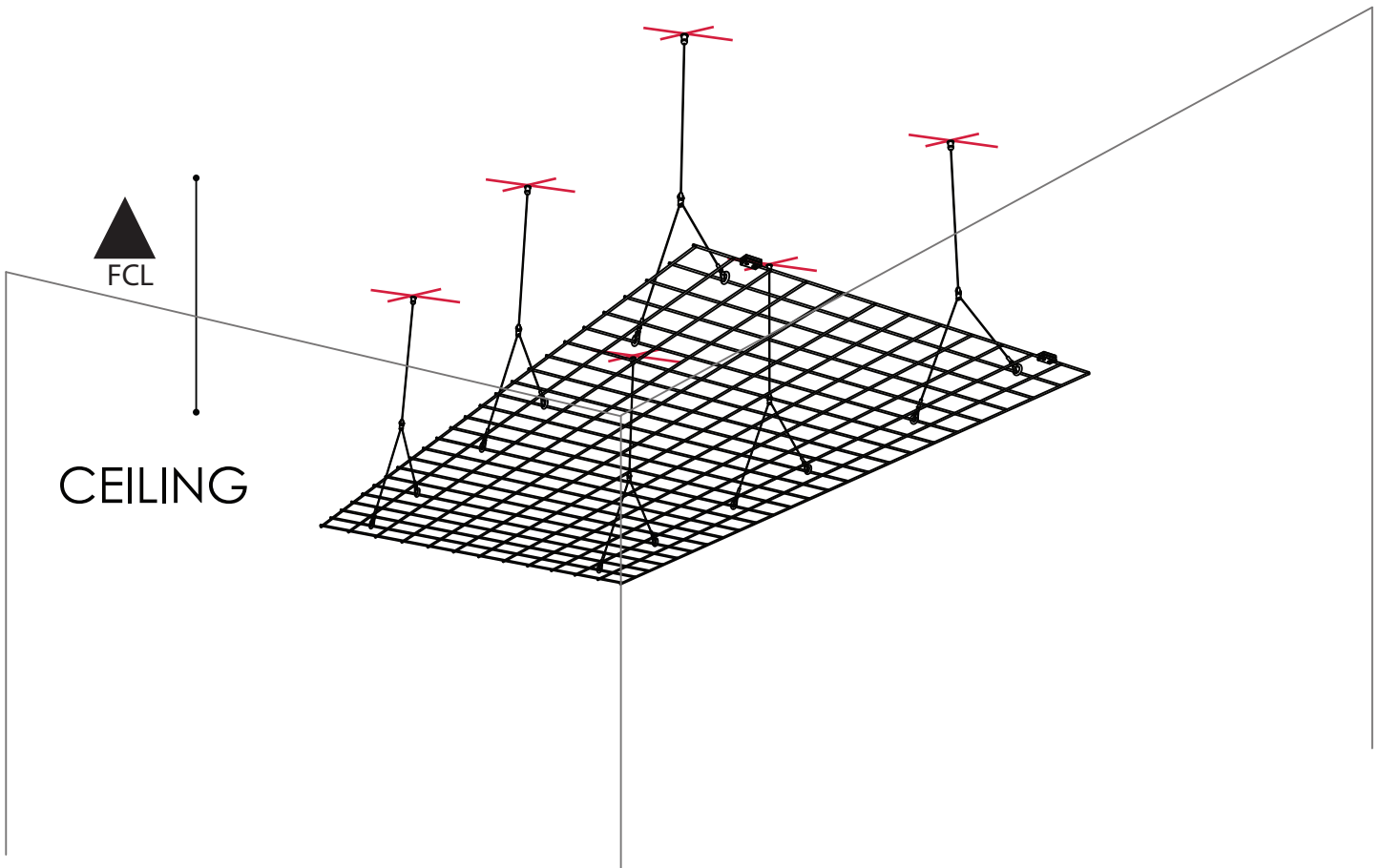

Figure 4





Hang the mesh onto the hooks. Follow the hook position from selected pattern



Zintra Mesh Baffles Installation Instructions

Adjust the height of Hanging assembly (B) to bring the Quill to the desired height
 Quill height is 167 mm (6.57") below the mesh.
 Level the mesh.

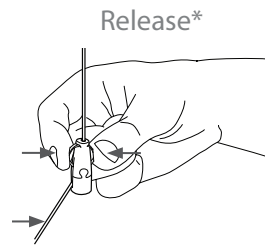

To adjust height hold clamp and pull cable

After desired system is level at finish height, cut excess cable leaving a minimum 1" (or 25mm)

measure mesh to laser in 6 pint where the hooks are located.

Max 5mm tolerance

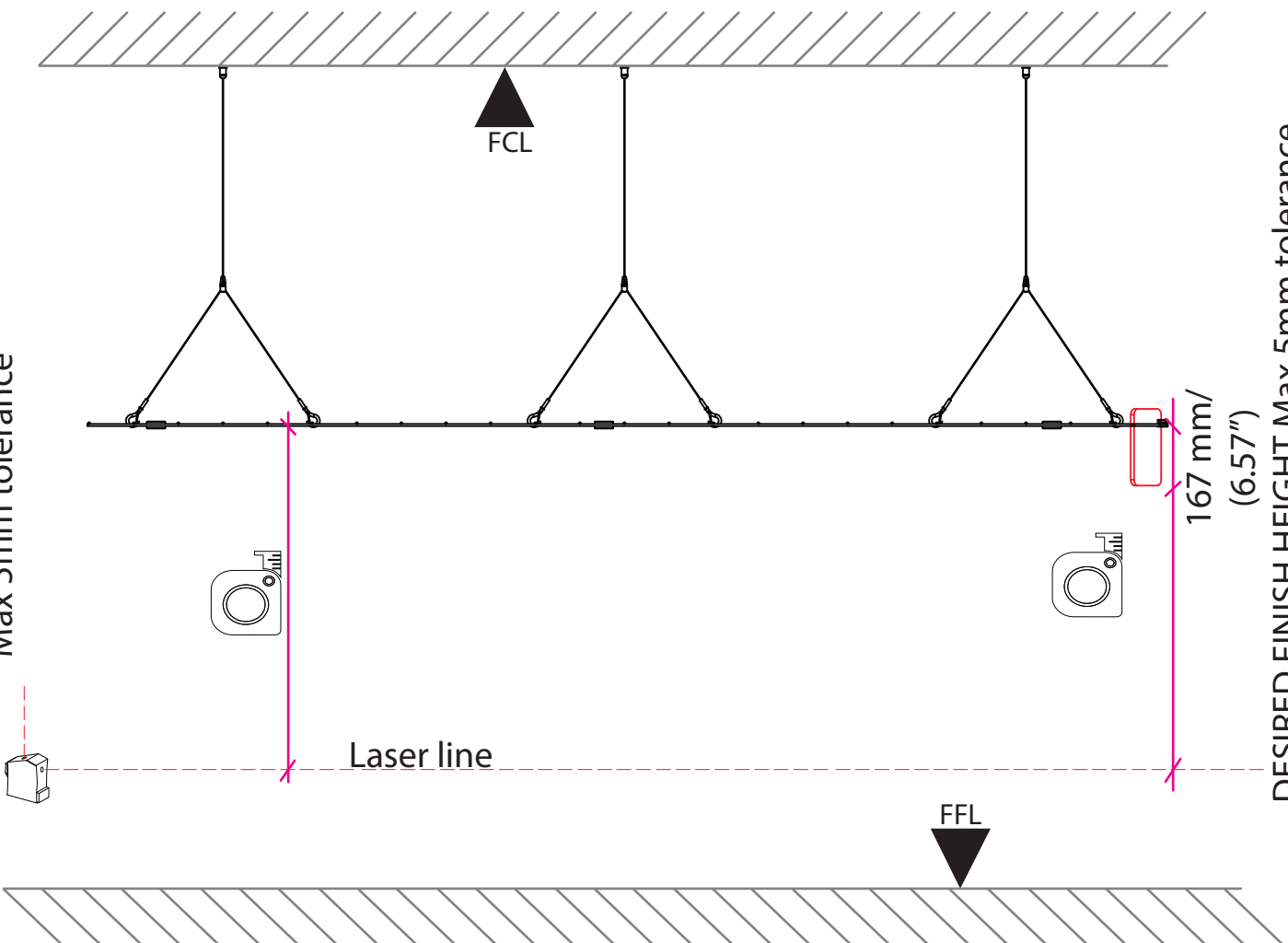

DESIRED FINISH HEIGHT Max 5mm tolerance

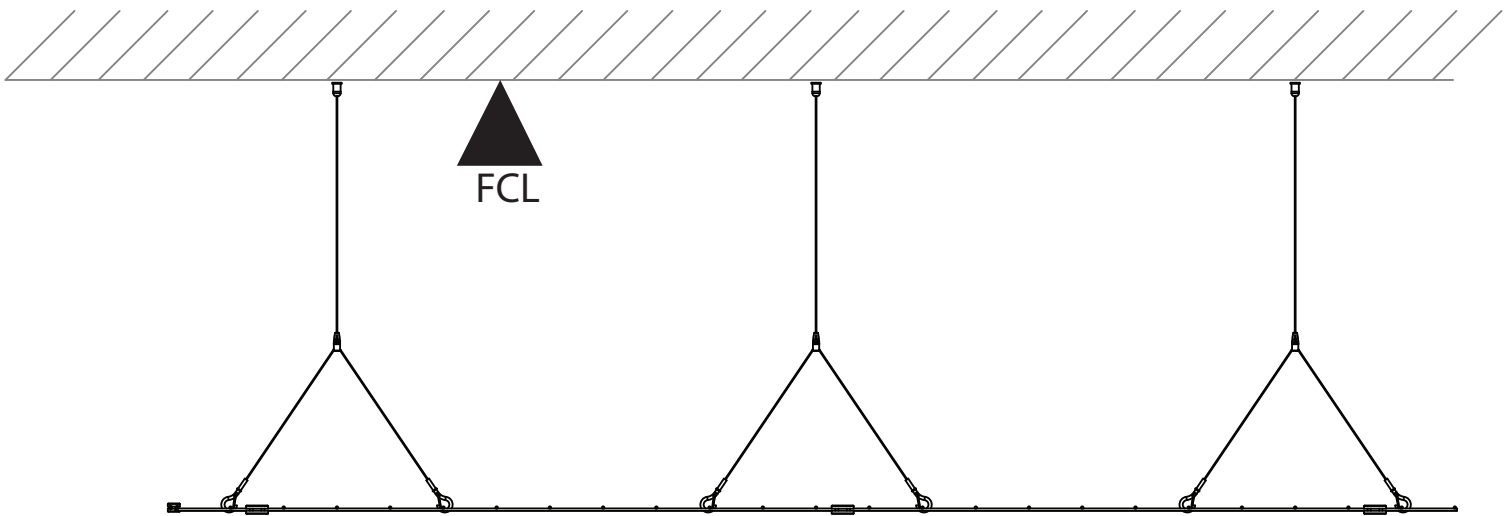
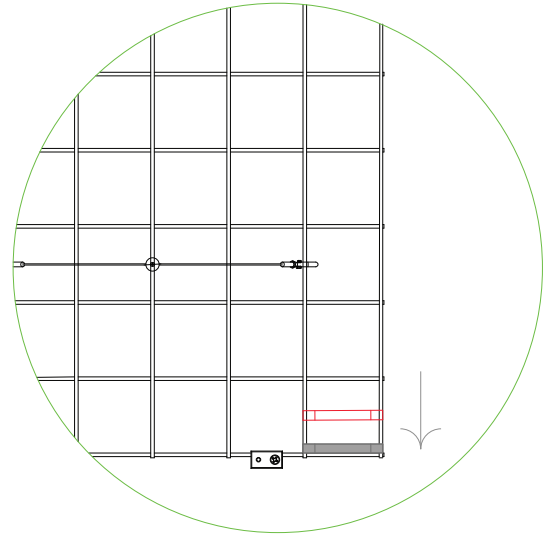
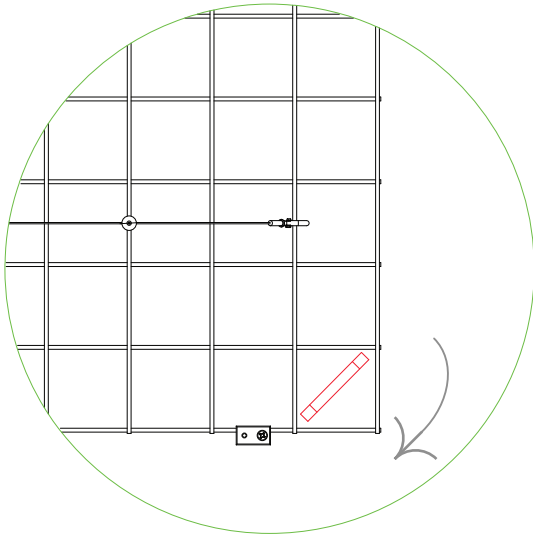

Lift and insert Quill at 45 degree
When the Quills receivers are in-line with the mesh
Rotate Quill to lock it in and push hard up to the mesh to secure
Follow selected patten

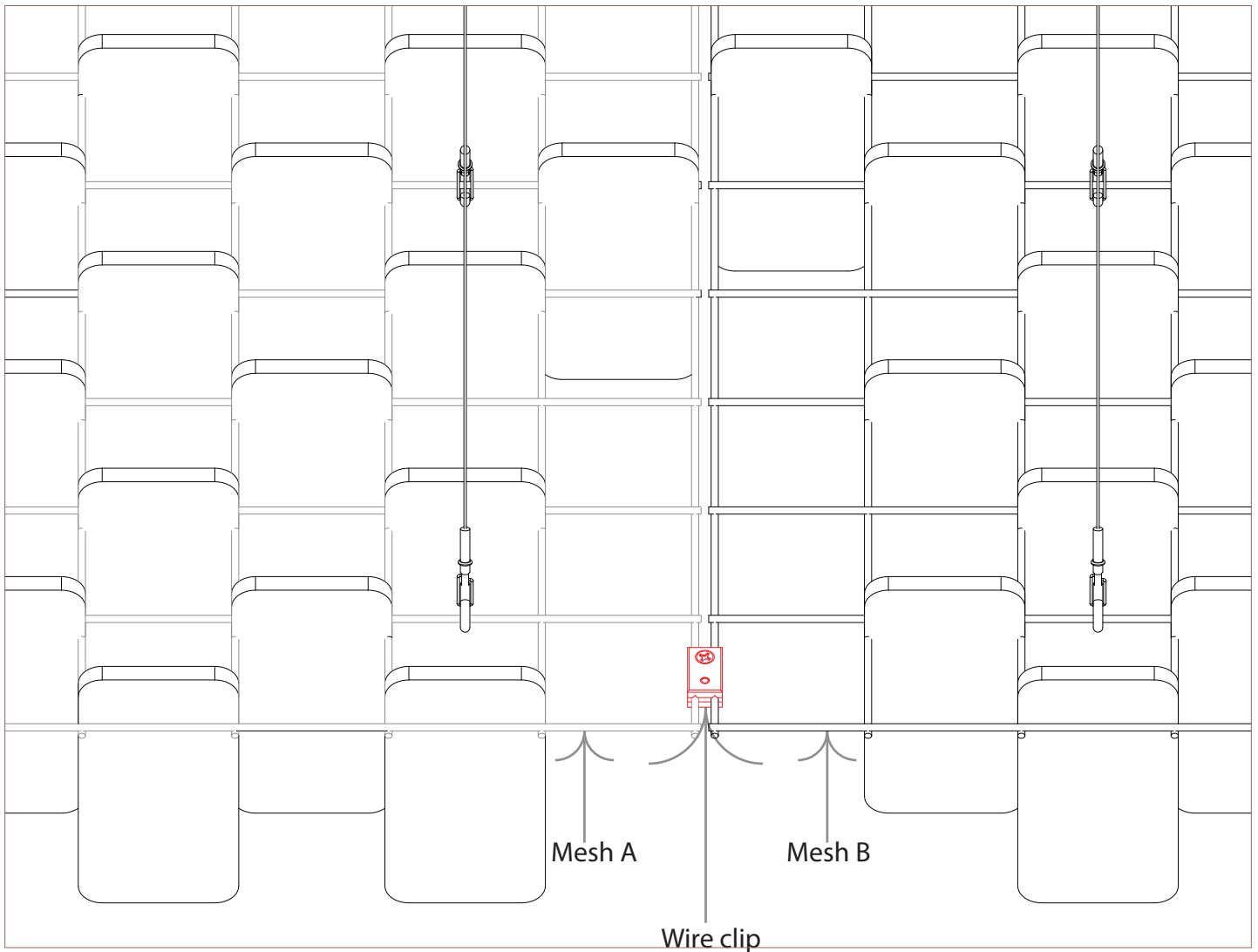

Use wire clip to join 2 or more meshes together

2 Clips on the short side (equally spaced) start from the corner

3 Clips on the long side (equally spaced) start from the corner

Mesh Baffle - Random

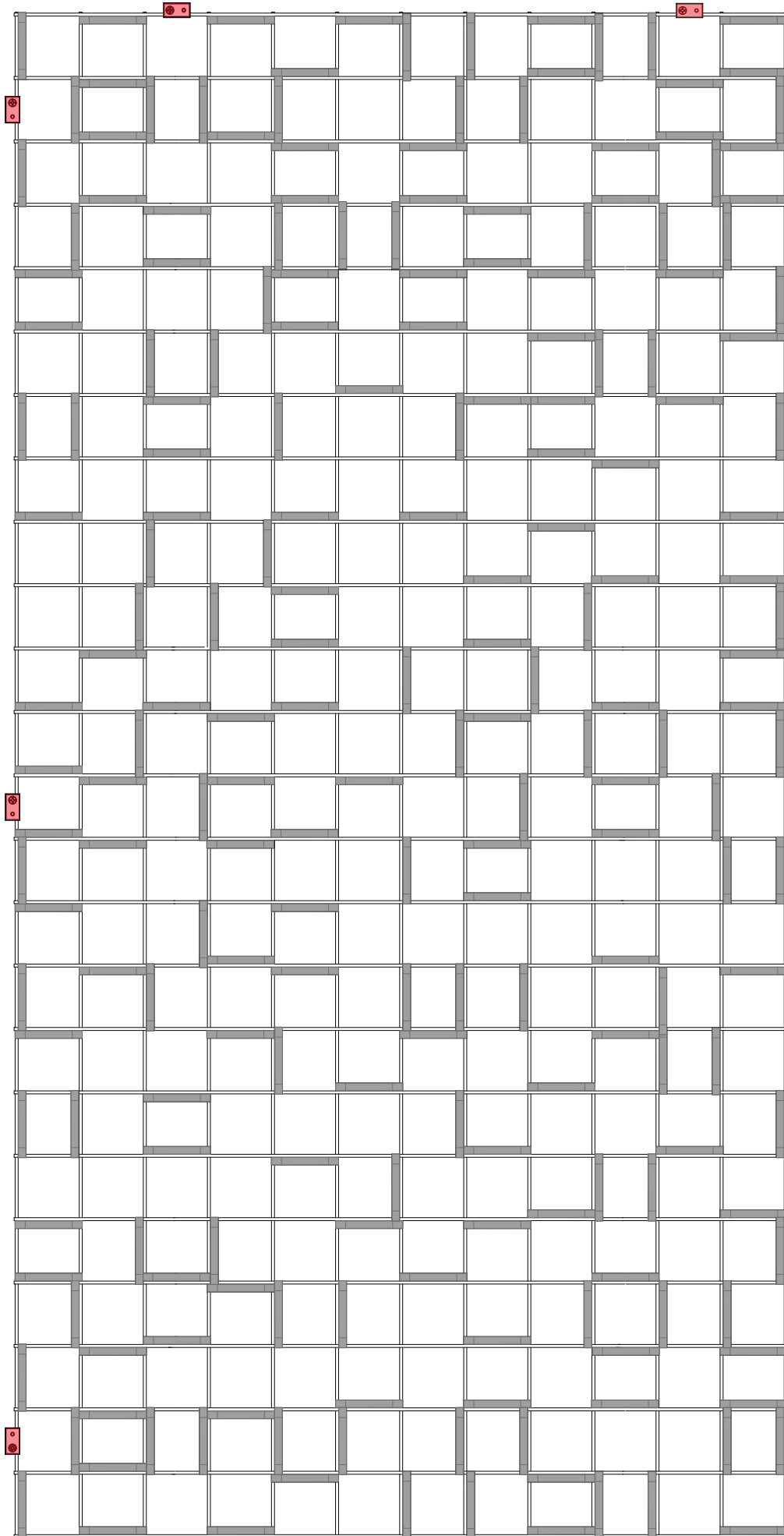

Mesh Baffle - Short Offset

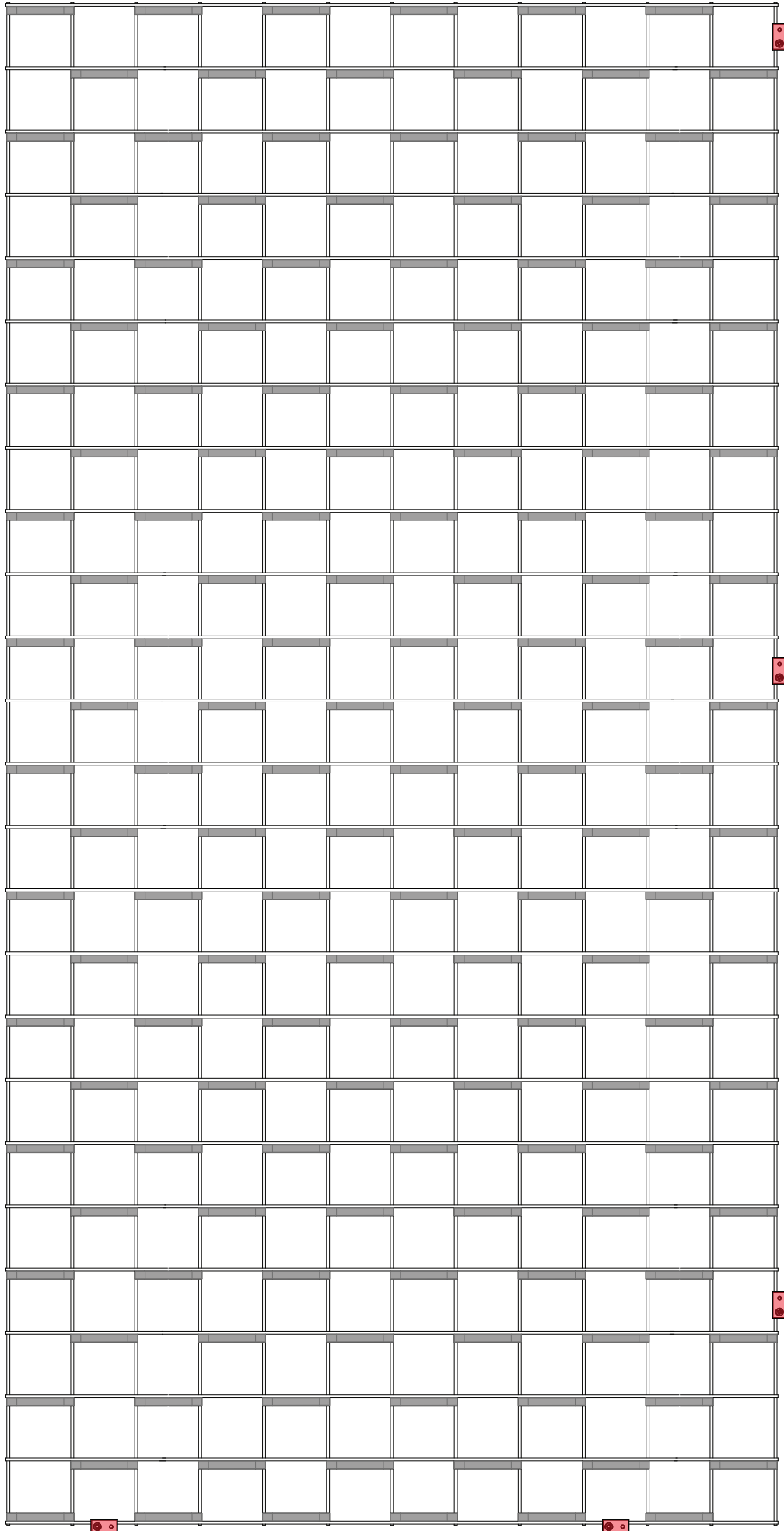

Mesh Baffle - Long Offset

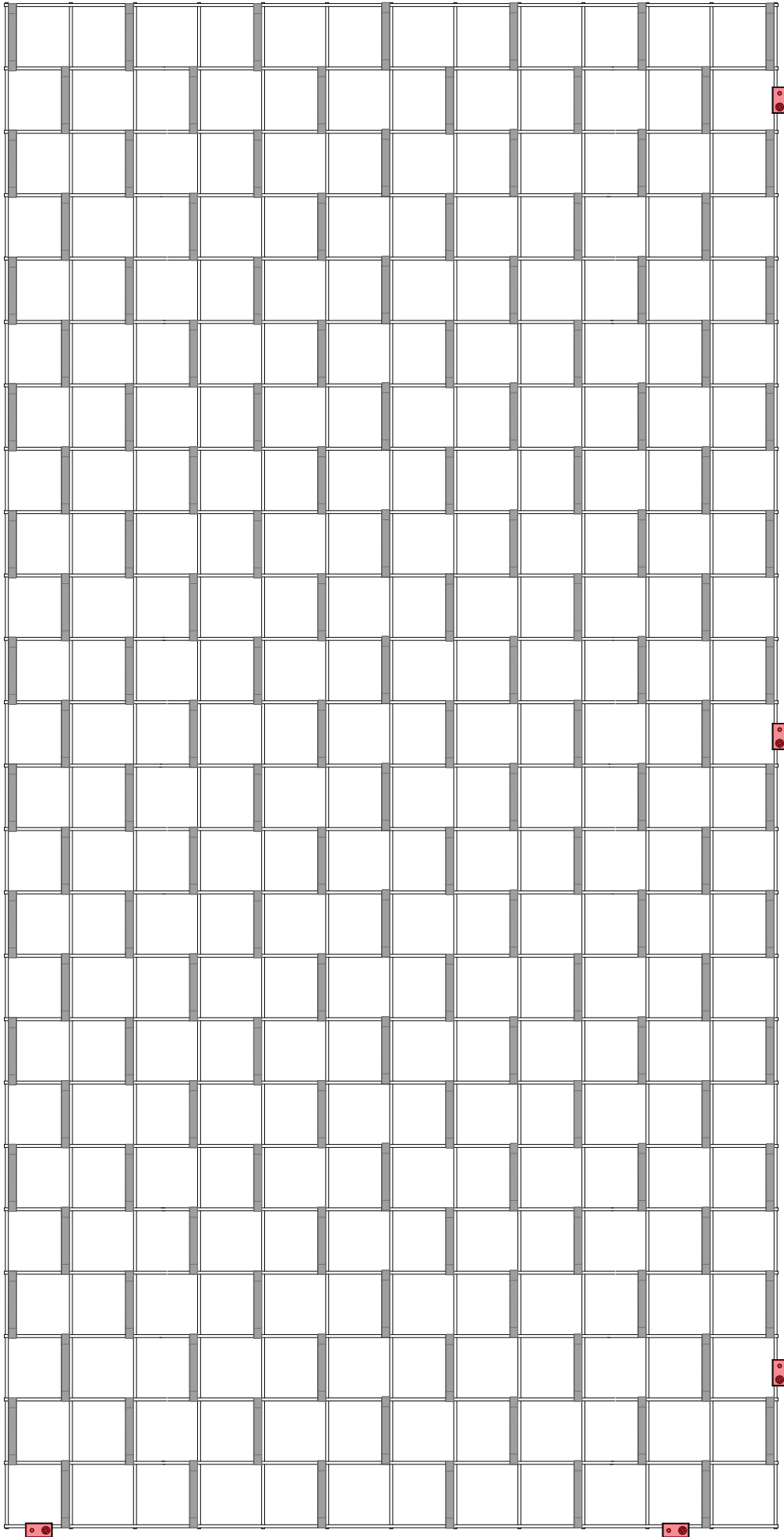

Mesh Baffle - Offset

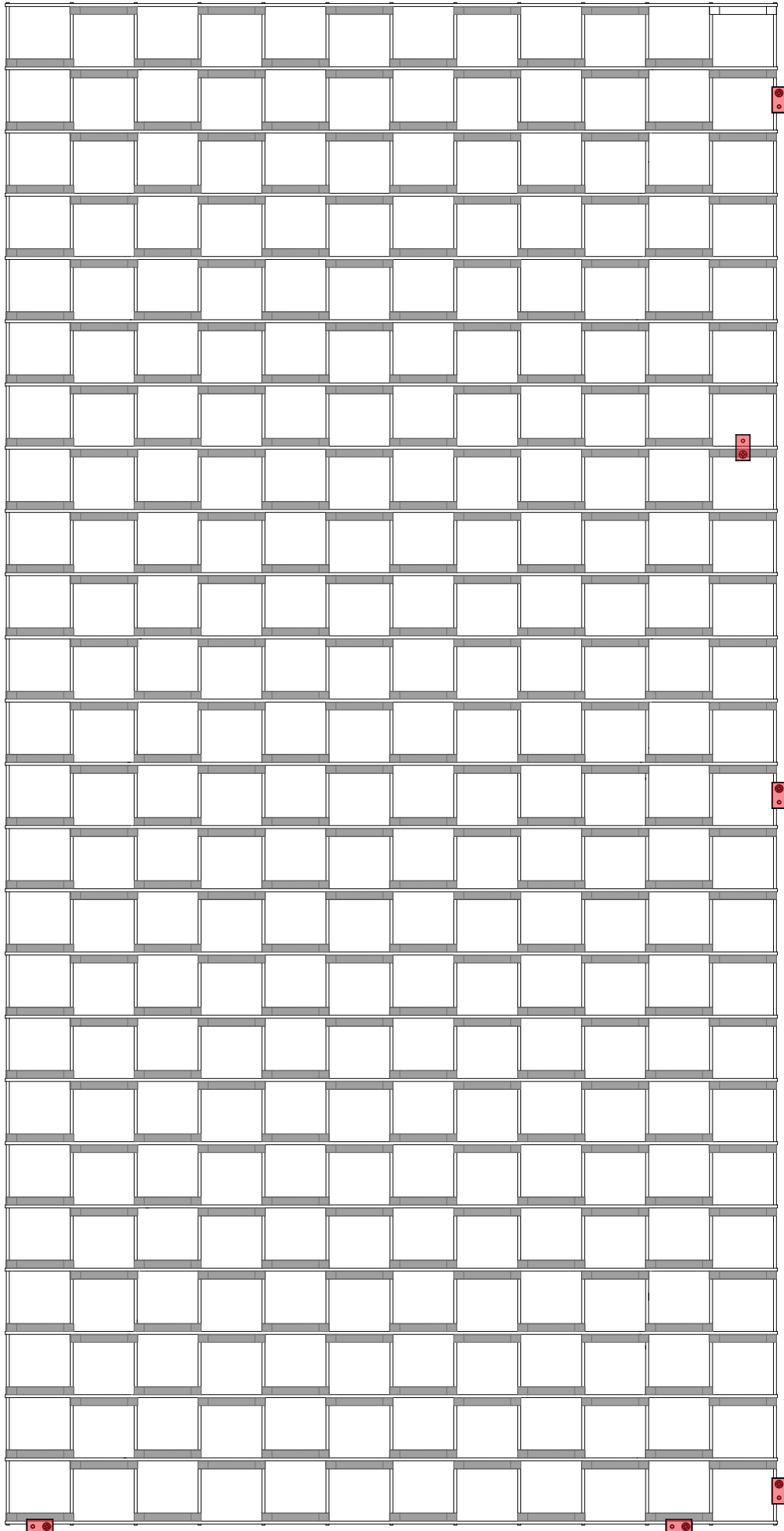

Mesh Baffle - Checkered

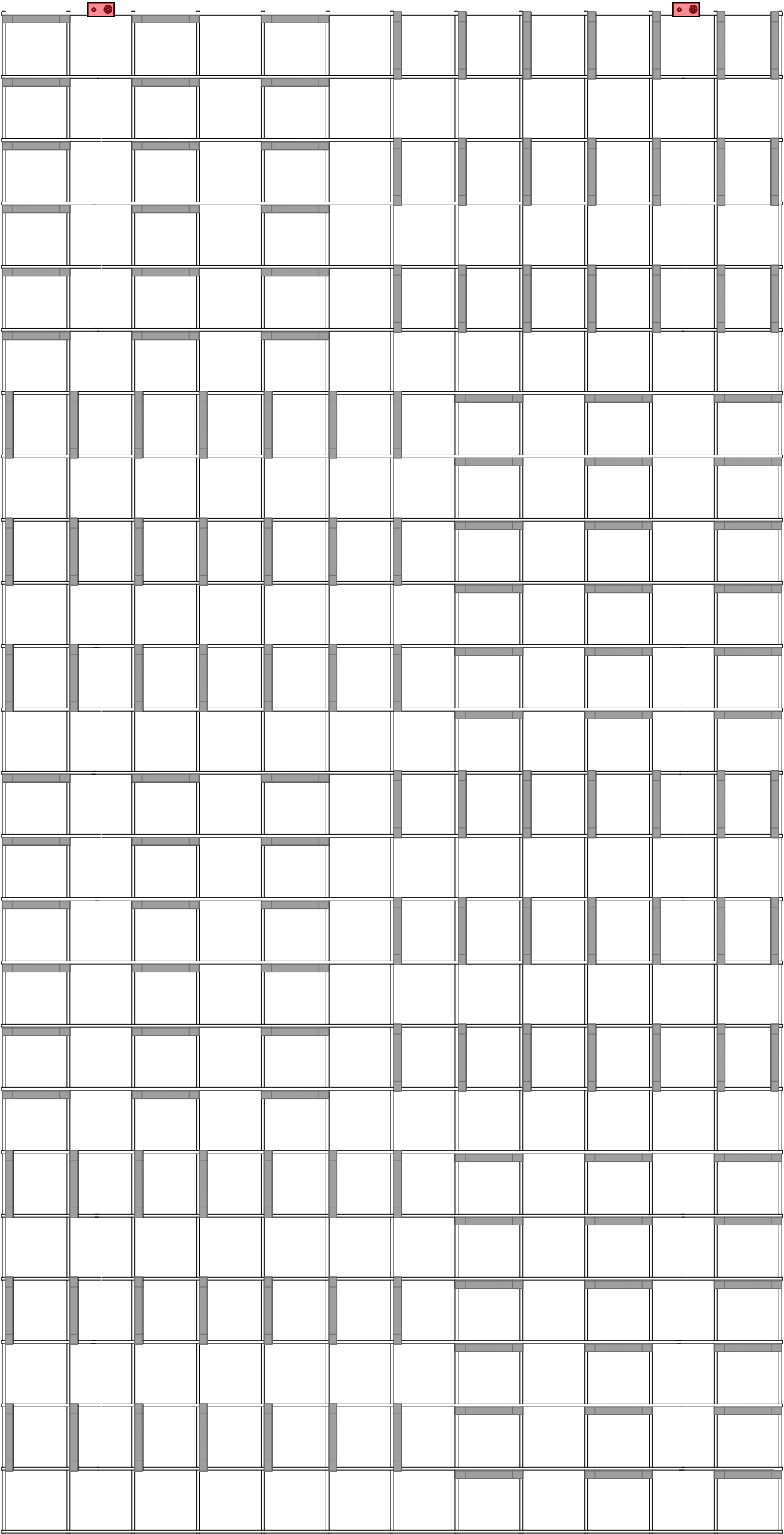

Mesh Baffle - Herringbone

